

## Dry Cell Traction Industrial Battery Block

Discover<sup>®</sup> Dry Cell Traction Series provide superior high integrity and reliability for commercial, industrial and private applications. The maintenance-free, thick plate construction, designed for tough applications and repeated deep discharging makes the EV Series the definitive choice for robust Traction applications including Home Medical Equipment (HME), Electric Vehicle, Automated Guided Vehicles (AGV), Aerial Lifts, Floor Cleaning Equipment, Robotics, Materials Handling, Renewable Energy and Marine / RV applications.

### MECHANICAL DRAWINGS

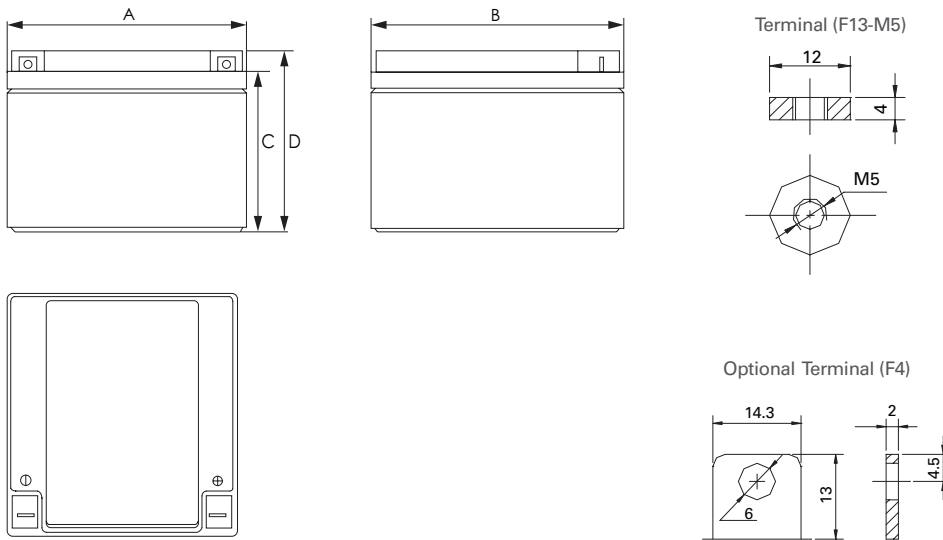

### MECHANICAL SPECIFICATIONS

Industry Reference	-	
Length (A)	6.5 in	166 mm
Width (B)	6.9 in	175 mm
Height (C)	4.8 in	121 mm
Total Height (D)	4.9 in	125 mm
Weight	17.6 lbs	8 kgs
Terminal (Opt'l)*	F13-M5 (F4)	
Cell(s)	6	
Electrolyte	1.2875 S.G.	AGM

NOTE: There is a tolerance of +/-2%.  
\*TERMINAL TORQUE: Please refer to our document, located in the Resources webpage ([www.discoverbattery.com/resources](http://www.discoverbattery.com/resources)).

### ELECTRICAL SPECIFICATIONS

Voltage	12V	
80% DOD Voltage Cutoff	11.4V	
Internal Resistance	10.50 mΩ	
Short Circuit (20°C   68°F)	1060 A	
Self Discharge	Less than 3% per month (20°C 68°F)	
Cranking Amps**	200 @ 0°C (32°F)	160 @ -18°C (0°F)
Charge Temperature	Min: -10°C (-14°F)   Max: 50°C (122°F)	
Discharge Temperature***	Min: -40°C (-40°F)   Max: 50°C (122°F)	
Storage	Min: -20°C (-4°F)   Max: 60°C (140°F)	

\*\*CRANKING AMPS: Cranking Amps data is provided as a reference only. Specific application sizing and life factors must be considered when using deep cycle product in a starting application.

\*\*\*CAUTION: Extra considerations must be given to depths of discharge, operating voltages and currents when designing systems for use at maximum temperatures.

### ELECTRICAL SPECIFICATIONS

Amp Hours (AH)						Minutes of Discharge				
100 HR	20 HR	10 HR	5 HR	3 HR	1 HR	@25A	@56A	@75A	@85A	@100A
29	26	23.5	22	20	16	31	-	-	-	-

Maximum Current	Peak (5 seconds)	Peak (10 seconds)	Continuous	Recommended Continuous
Charge	1C10Hr	0.75C10Hr	0.5C10Hr	0.3C10Hr
Discharge	2C10Hr	1.5C10Hr	1C10Hr	0.5C10Hr

### BENEFITS & FEATURES

Advanced battery designs that exceed Original Equipment Manufacturer requirements.

Enhanced alloy Traction heavy duty grids gives consistent active material adhesion and corrosion resistance for longer runtime and extended service life.

Higher density active material paste to deliver longer runtimes at high discharge currents.

Lower specific gravity for reduced heat and cycle life performances.

High impact reinforced copolymer and polypropylene cases with flat top designs.

Sealed Non-Spillable Maintenance-free technology.

99.9% gas recombination reduces off gassing and water loss.

Multiple battery terminal options and carrying handles available.

Excellent for use in environmentally sensitive areas.

UL94 recognized flame arresting low pressure safety vents (UL94 V0 rating available).

Classified as a non-spillable battery is not restricted for transportation by:

- Air (IATA/ICAO provision 67)
- Ground (STB, DOT-CFR-HMR49)
- Water (IMDG amendment 27)

### CERTIFIED QUALITY

Discover<sup>®</sup> and its facilities and products are tested and certified to multiple standards:

- ISO, UL, CE, and QS standards
- ETTS Germany
- Euro Bat classification for Environmental Stewardship Standards

Designed in accordance with and published in compliance with applicable BCI, IEC and BS EN standards, including:

- IEC60896-21/22
- BS EN 60254-1:2005
- AS/NZS 4029.2:2000



**NOTE:**

IUI with Pulse Termination algorithm uses a pulse termination criterion. As a safety precaution during the Finish phase, if the average cell voltage, or volts per cell (vpc), exceeds U2 and the charger output has been on for more than 30 seconds, the output is shut off until the vpc falls to U3. The finish phase then resumes and this "pulsing" continues until the target overcharge (108% - 112%) is reached.

**NOTE 2:**

Please note the voltage settings displayed in the IUI with Pulse Termination Charge Profile graph, corresponds to the set points at 25°C (77°F). For temperatures below 25°C, adjust +0.005VPC/°C (or 0.003VPC per °F). For temperatures above 25°C, adjust -0.005VPC/°C (or 0.003VPC per °F).

$$\Delta V = (T - 25^\circ\text{C}) \times \left( \frac{-0.005\text{VPC}}{^\circ\text{C}} \right)$$

**TEMPERATURE EFFECTS ON CAPACITY**



**CYCLE LIFE IN RELATION TO DEPTH OF DISCHARGE (25°C)**

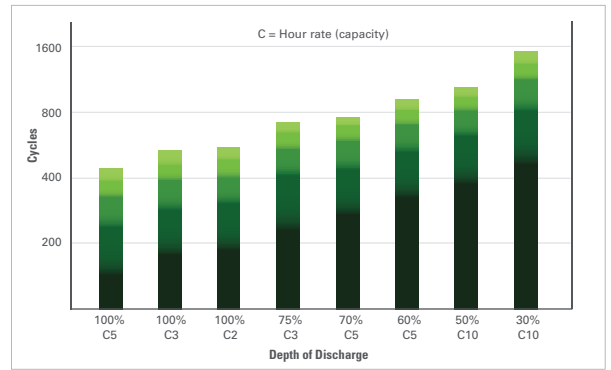

**OPEN CIRCUIT VOLTAGE IN RELATION TO THE STATE OF CHARGE (20°C)**



**SELF-DISCHARGE CHARACTERISTICS**

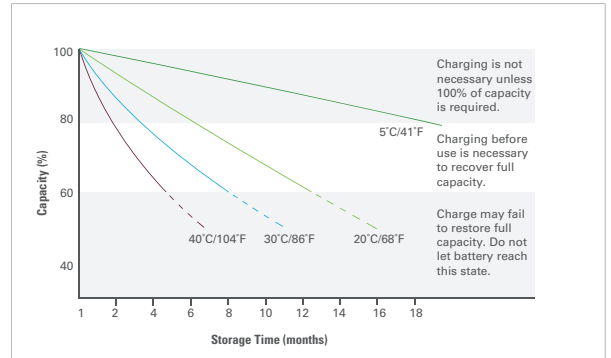

**IUI WITH PULSE TERMINATION CHARGE PROFILE**

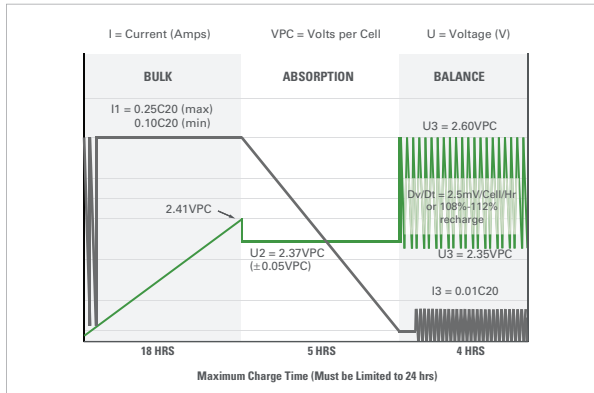

**IUI CHARGE PROFILE**

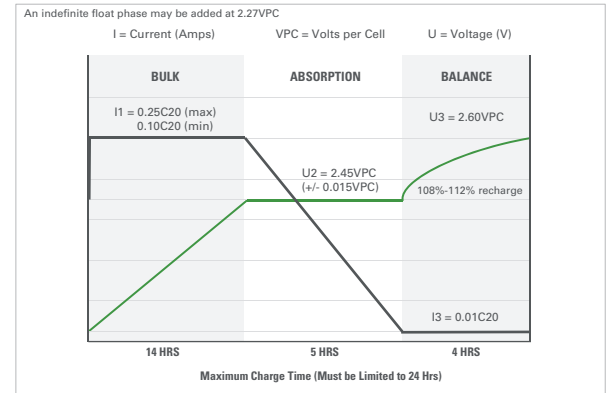

**IUU CHARGE PROFILE**

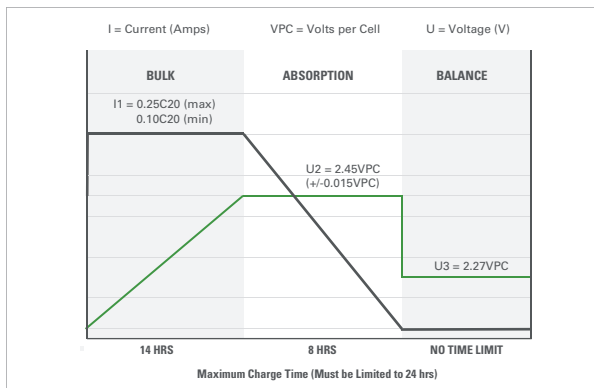

**RELATION BETWEEN CHARGING, VOLTAGE AND TEMPERATURE**

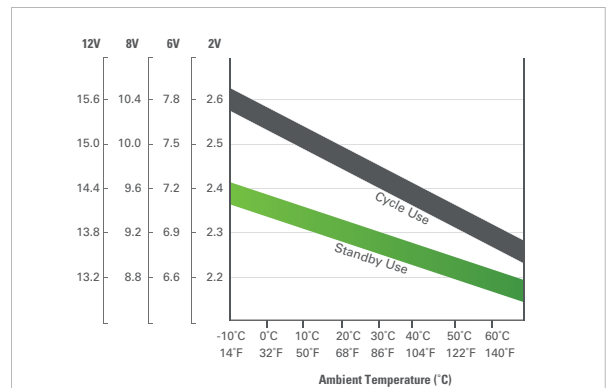

Discover® attempts to ensure the correctness of the product description and data contained herein. We reserve the right to change designs, specifications and pricing at any time without notice or obligation. It is the responsibility of the reader of this information to verify any and all information presented herein.